

# Service Service Service

www.lurpaks.com

www.videopac.org

www.videopacnews.com



15 300 A11

# Service Manual

## VIDEOPAC COMPUTER

(GB)

### SPECIFICATION

UHF channel	32 (559,25 MHz)
Aerial impedance	75 Ω
Mains voltage	220 V~
Mains voltage (British version)	240 V~
Supply voltage	10 V d.c./1.1A
Number of IC's (without game cartridge)	32
Number of transistors	3
Number of diodes	8

(D)

### TECHNISCHE DATEN

UHF-Kanal	32 (559,25 MHz)
Antennenimpedanz	75 Ω
Netzspannung	220 V~
Netzspannung (englische Ausführung)	240 V~
Speisespannung	10 V d.c./1.1A
Anzahl der IC's (ausschliesslich der Spielcassette)	32
Anzahl der Transistoren	3
Anzahl der Dioden	8

(I)

### DATI TECNICI

Canale UHF	32 (559,25 MHz)
Impedenza d'antenna	75 Ω
Tensione di rete	220 V~
Tensione di rete (versione Inglese)	240 V~
Tensione di alimenta- zione	10 V d.c./1.1A
Numero di CI (escluse le cassette dei giochi)	32
Numero dei transistors	3
Numero dei diodi	8

(NL)

### SPECIFICATIE

UHF-kanal	32 (559,25 MHz)
Antenne-impedantie	75 Ω
Netspanning	220 V~
Netspanning (Britse versie)	240 V~
Voedingsspanning	10 V d.c./1.1A
Aantal IC's (exclusief de spelcassette)	32
Aantal transistoren	3
Aantal diodes	8

(F)

### CARACTERISTIQUES TECHNIQUES

Canal UHF	32 (559,25 MHz)
Impédance d'antenne	75 Ω
Tension secteur	220 V~
Tension secteur (version pour GB)	240 V~
Tension d'alimentation	10 V d.c./1.1A
Nombre d'IC (sans cassette jeux)	32
Nombre de transistors	3
Nombre de diodes	8

(S)

### SPECIFIKATION

UHF-kanal	32 (559,25 MHz)
Antenneimpedans	75 Ω
Nätspanning	220 V~
Nätspanning (Engelsk version)	240 V~
Matningsspanning	10 V d.c./1.1A
Antal IC (utom spelkassetter)	32
Antal transistorer	3
Antal dioder	8



GB

## ADJUSTMENTS

### Clock frequency

- Connect a frequency counter to 61C678.
- Adjust C777 for a frequency of 4,433619 MHz.

### Modulation depth

- Adjust R748 for optimal picture and sound quality.

### UHF-adjustment

- The G7000 is adjusted during production to channel 32.
- The UHF-adjustment can be varied from channel 31 to channel 33 by L650.
- The other coils of U100 must remain unchanged.

NL

## INSTELLINGEN

### Klokfrequentie

- Sluit een frequentieteller aan op 61C678.
- Regel C777 af op een frequentie van 4,433619 MHz.

### Modulatiediepte

- Stel R748 in voor optimale beeld en geluidskwaliteit.

### UHF-afstemming

- Tijdens de productie wordt de G7000 ingesteld op kanaal 32.
- Met L650 kan de UHF-afstemming gevarieerd worden van kanaal 31 tot kanaal 33.
- De andere spoelen van U100 moeten ongewijzigd blijven.

D

## EINSTELLUNGEN

### Taktfrequenz

- Einem Frequenzzähler an 61C678 anschliessen.
- C777 auf eine Frequenz von 4,433619 MHz abgleichen.

### Modulationstiefe

- R748 für optimale Bild- und Tonqualität einstellen.

### UHF-Abstimmung

- Während der Fertigung wird G7000 auf Kanal 32 eingestellt.
- Mit L650 kann die UHF-Abstimmung von Kanal 31 bis Kanal 33 variiert werden.
- Die übrigen Spulen von U100 müssen nicht geändert werden.

F

## AJUSTAGES

### Fréquence d'horloge

- Relier un fréquencesmètre au 61C678
- Régler C777 à une fréquence de 4,433619 MHz

### Profondeur de modulation

- Aligner R748 pour l'obtention d'une qualité d'image et de son optimale.

### Alignement UHF

- En cours de fabrication, le G7000 est ajusté sur le canal 32.
- L'ajustement UHF peut être modifié du canal 31 au canal 33 par L650.
- Les autres bobines de U100 ne doivent pas être changées.

I

## REGOLAZIONI

### Frequenza di clock

- Collegare un frequenzimetro sul 61C678.
- Regolare per una frequenza di 4,433619 MHz

### Profondità di modulazione

- Regolare R748 per ottenere l'ottimale di qualità audio e video.

### Regolazione dell'uscita UHF

- Il G7000 è regolato in fabbrica sul canale 32.
- E' possibile variare il canale di uscita su 31 o 33 con L650
- Le altre bobine comprese en U100 non devono essere toccate.

S

## JUSTERINGAR

### Klockfrekvens

- Anslut en frekvensräknare till 61C678.
- Justera C777 till en frekvens av 4,433619 MHz.

### Modulationsdjup

- Justera R748 till optimal bild och ljudkvalitet.

### UHF-inställning

- G7000 är fabriksinställd till kanal 32.
- UHF-inställningen kan varieras från kanal 31 till kanal 33 med L650.
- De andra spolarna i U100 får ej ändras.

[www.videopac.org](http://www.videopac.org)

[www.lurpaks.com](http://www.lurpaks.com)

[www.videopacnews.com](http://www.videopacnews.com)

C	615, 614	607, 609	608	663, 658, 665, 611, 656, 664, 662	674, 660, 661, 657, 659	673	672, 671	670, 675	676, 677
	616	655		666, 667	610	679, 678	680, 681	668, 669, 683	682

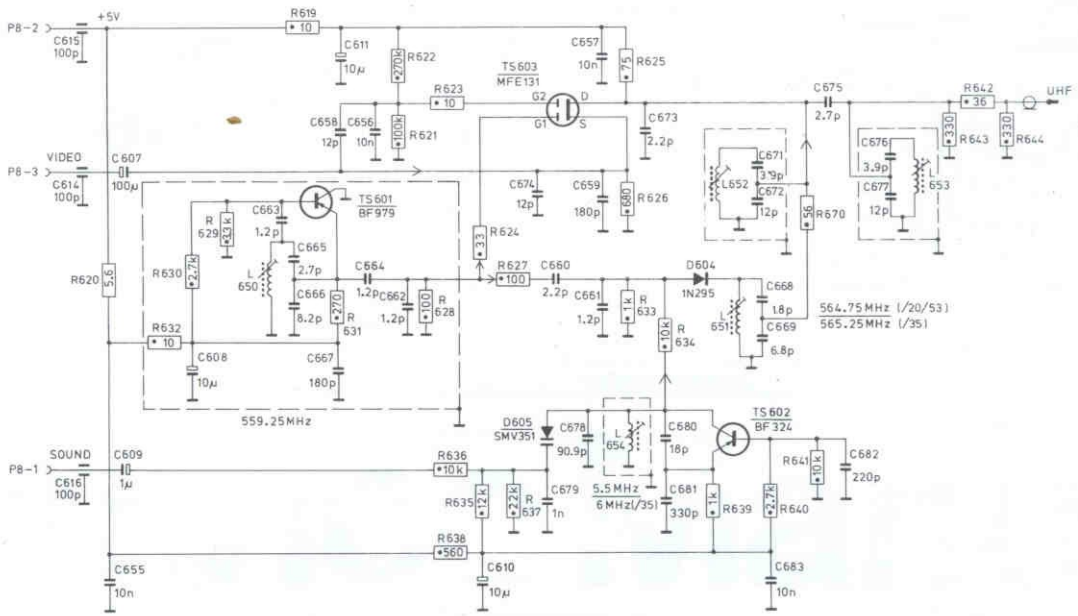

D-L-TS	L650			TS601		TS603, D605			L654		D604, L651, TS602, L652		L653	
R	620	630, 632	629	619	631	622, 621, 623, 628, 624, 627	638, 638, 635, 637	625, 626, 633, 634	639	640	641	643, 642	644	

22 467C8

www.videopac.org  
 www.lurpaks.com  
 www.videopacnews.com

MISC.	TS601	L605, TS603	L657	L651, D604, L653	L654, D605	MISC.
C	611, 667, 657, 607 + 609, 659, 655, 674, 662 + 666, 656, 658, 669 + 672, 610, 668, 660, 673, 675 + 683					
R	619 + 622, 629 + 632, 626, 625, 638, 623, 624, 628	627	640, 633 + 635, 639, 637, 641 + 644			

MISC.	D605, L654	L653, D604, L651	L657	TS603, L605	TS601	MISC.
C	675 + 683, 673, 660, 668, 610, 669 + 672, 658, 656, 662 + 666, 674, 655, 659, 607 + 609, 657, 667, 611					
R	641 + 644, 637, 639, 633 + 635, 640	627	628, 624, 623, 635, 638, 625, 626, 629 + 632, 619 + 622			

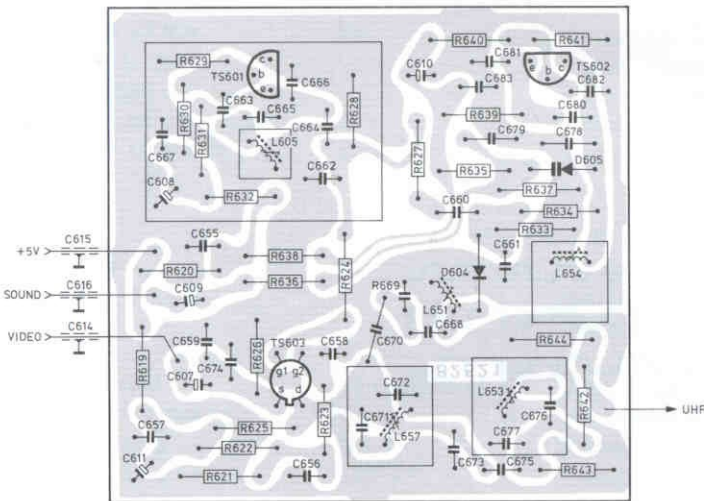

22 882 C12

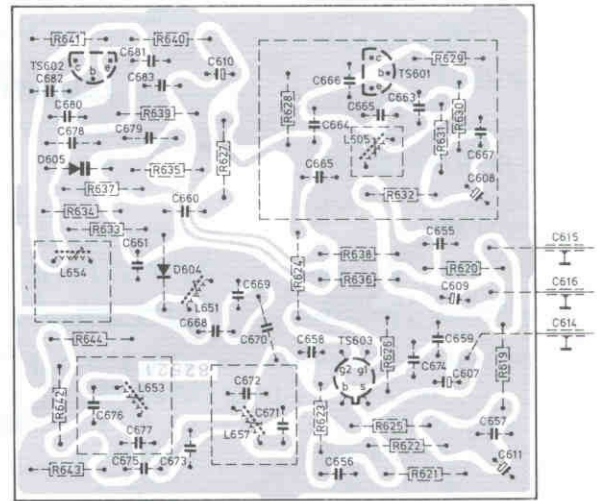

22 883 C12

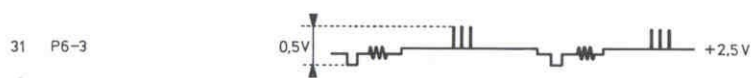
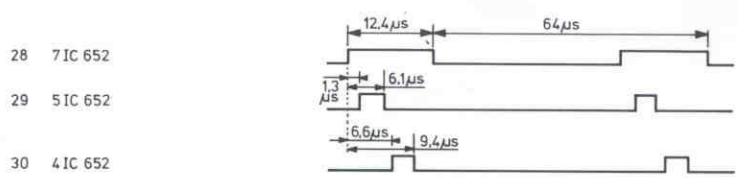
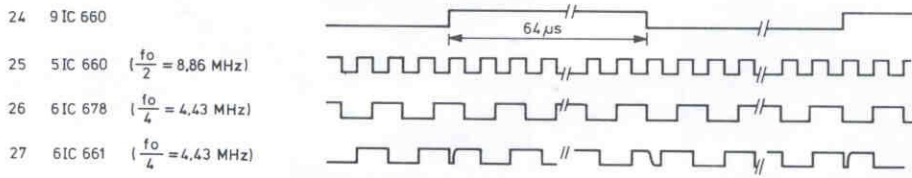
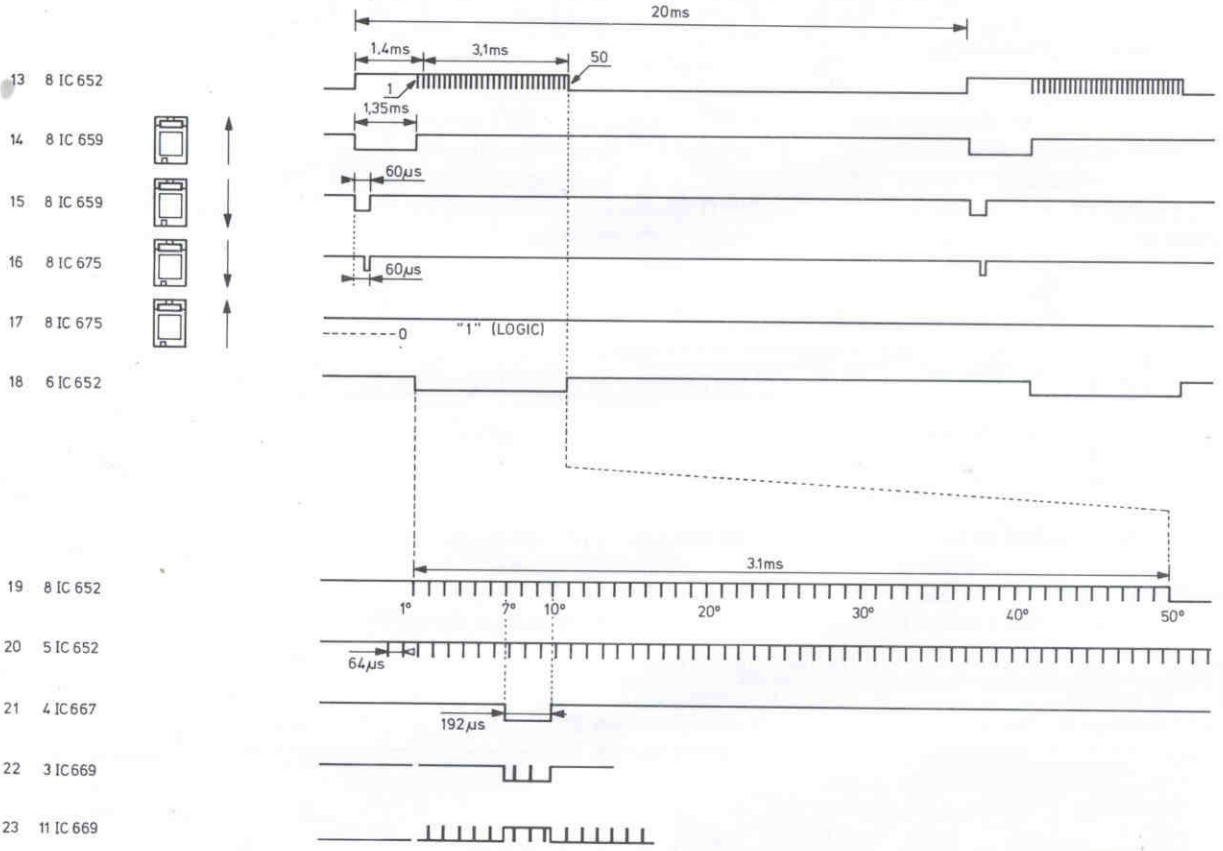
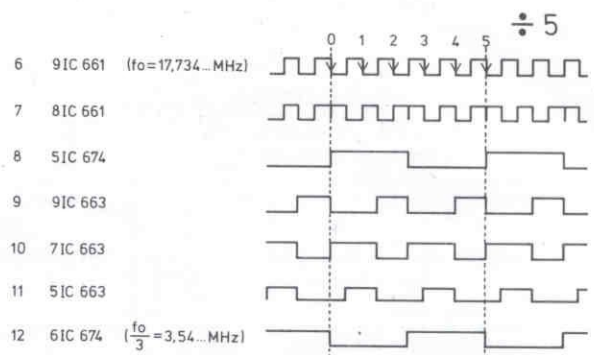
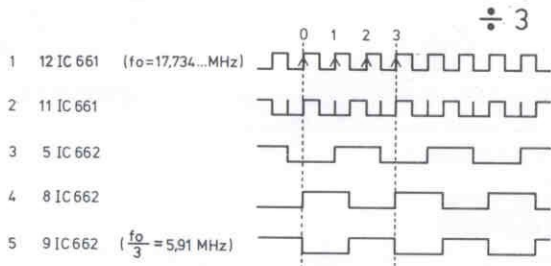

[www.videopac.org](http://www.videopac.org)  
[www.lurpaks.com](http://www.lurpaks.com)  
[www.videopacnews.com](http://www.videopacnews.com)



D1	1N4001	5322 130 30197
D2	1N4001	5322 130 30197
D3	1N4001	5322 130 30197
D4	1N4001	5322 130 30197
D604	1N295	4822 130 31426
D605	SMV351	4822 130 31427
D687	1N4148	4822 130 30621
D688	OA90	4822 130 30219
D689	1N4148	4822 130 30621



TS601	BF979	4822 130 41613
TS601	BF324	4822 130 41448
TS603	MFE131	4822 130 41614



C607	100 $\mu$ F - 10 V	4822 124 20679
C608	10 $\mu$ F - 25 V	4822 124 20697
C609	1 $\mu$ F - 63 V	4822 124 20722
C610	10 $\mu$ F - 25 V	4822 124 20697
C611	10 $\mu$ F - 25 V	4822 124 20697
C777	3 - 10 pF	4822 125 50135
C779	1 $\mu$ F	4822 124 20722
C782	10 $\mu$ F - 25 V	4822 124 20697
C783	1 $\mu$ F - 63 V	4822 124 20722
C812	1 $\mu$ F - 63 V	4822 124 20722
C816	15 $\mu$ F - 40 V	4822 124 20709
C850	10 $\mu$ F - 25 V	4822 124 20697
C853	10 $\mu$ F - 25 V	4822 124.20697
C871	47 $\mu$ F - 25 V	4822 124 20699
C876	4700 $\mu$ F - 25 V	4822 124 70316

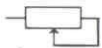

R748	470 $\Omega$	4822 100 10038
L695		4822 158 20381
X693	17,73.. MHz	4822 242 70276
VL1	T160 mA	4822 253 30009
VL1	T140 mA	4822 253 30008
VL3	T4A	4822 253 30028



IC651	8048	4822 209 50002
IC652	8245	4822 209 80449
IC653	6810	4822 209 50003
IC654	74LS168	4822 209 80452
IC655	74LS175	5322 209 84999
IC656	74LS175	5322 209 84999
IC657	74LS156	4822 209 80446
IC658	74LS365	4822 209 80453
IC659	74LS74	4822 209 80782
IC660	74LS74	4822 209 80782
IC661	74S86	5322 209 85452
IC662	74S74	5322 209 84183
IC663	74S112	5322 209 84237
IC664	74LS393	4822 209 80447
IC665	74LS138	5322 209 85647
IC666	74LS138	5322 209 85647
IC667	74LS279	5322 209 85346
IC668	74LS00	5322 209 84823
IC669	74LS00	5322 209 84823
IC670	74LS32	5322 209 85311
IC671	74LS32	5322 209 85311
IC672	74LS04	4822 209 80783
IC673	74LS368	4822 209 80448
IC674	74S112	5322 209 84237
IC675	74LS20	5322 209 85569
IC676	74LS02	5322 209 85312
IC677	74LS365	4822 209 80453
IC678	74S74	5322 209 84183
IC679		4822 209 80451
IC680	74S04	5322 209 85486
IC681	L7805CV	4822 209 80817
IC682	L7805CV	4822 209 80817

[www.videopac.org](http://www.videopac.org)

[www.lurpaks.com](http://www.lurpaks.com)

[www.videopacnews.com](http://www.videopacnews.com)

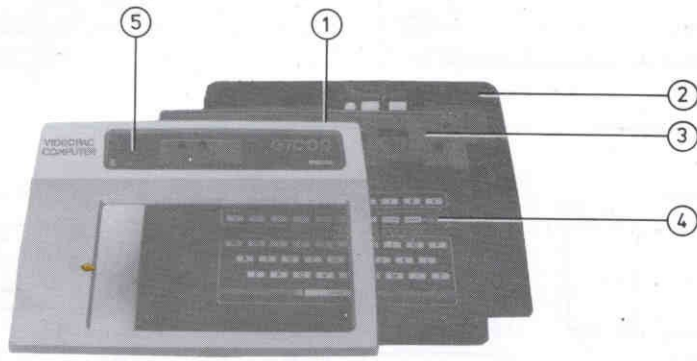

23 401 A12

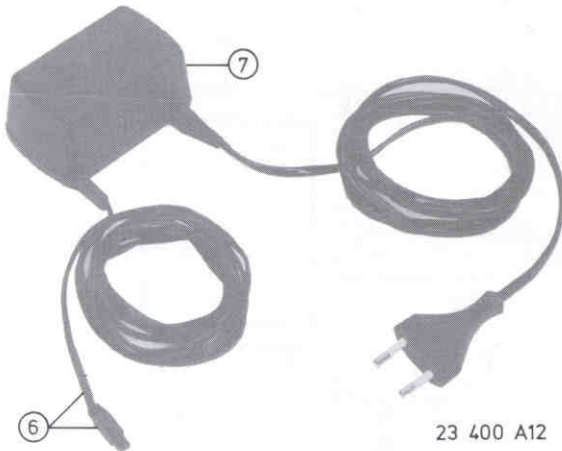

23 400 A12

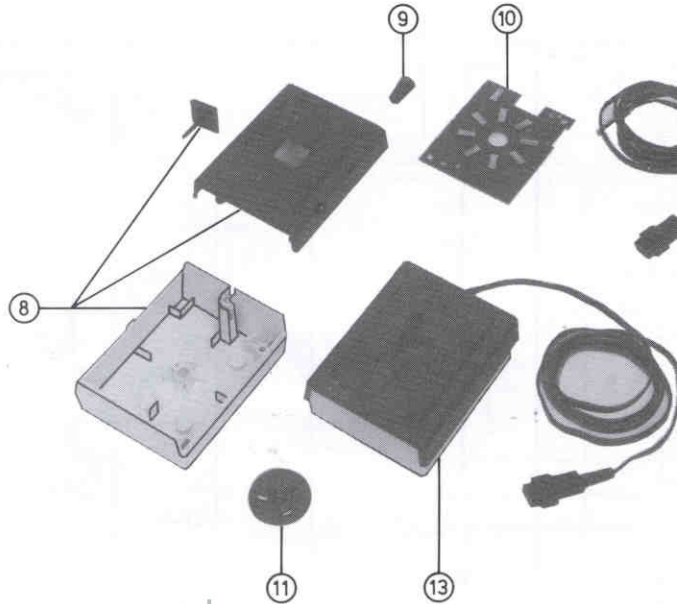

23 403

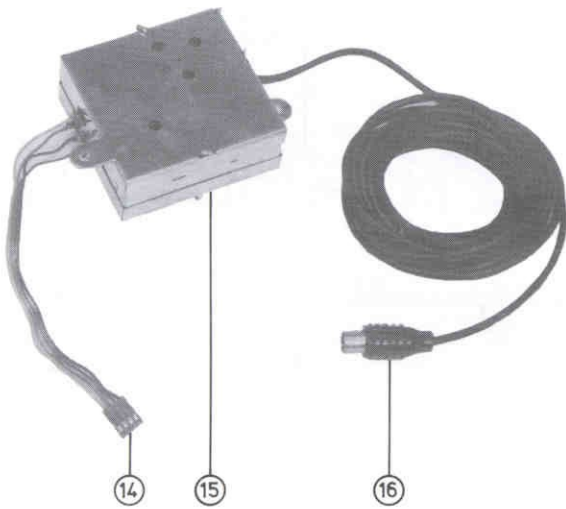

23 402 A12

www.videopac.org  
 www.lurpaks.com  
 www.videopacnews.com

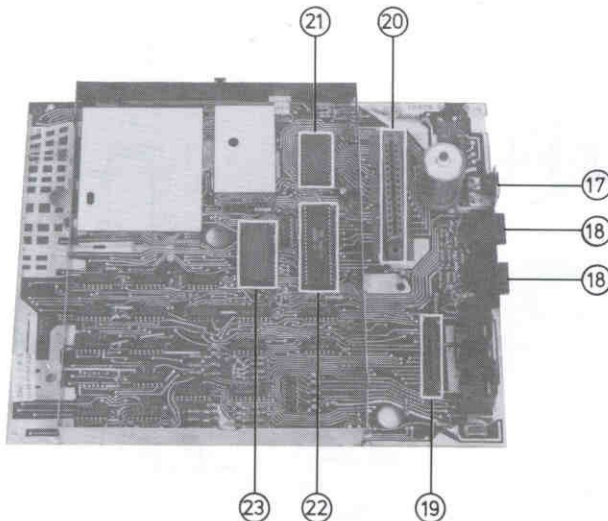

23 404 A12

1		4822 432 30
2	}	4822 219 80
3		4822 454 10
4		4822 219 80
5		4822 454 10
6		4822 321 20
7	220 V~	4822 219 80
7	240 V~	4822 219 80
8		4822 432 30
9		4822 413 30
10		4822 464 90
11		4822 462 40
12		4822 321 20
13	8+9+10+11+12	4822 441 80
14		4822 265 30
15	5,5 MHz	4822 212 10
15	6 MHz	4822 212 10
16		4822 264 30
17		4822 290 80
18		4822 267 50
19		4822 265 40
20	(2x15)	4822 265 40
21	(24)	4822 267 30
22	(40)	5322 255 44
23	(28)	5322 255 44
24	(16)	5322 255 44

IC	680	681	677	680	680	657	662a	662b	663b	651	674	679	782	670a	672a						
C	775-810	775	809,810	806	788...792	802...807	794...801	785	661d	654	661c	663a	783	663b	658c	659a					
B11-	857,814,858,813,849,815,822,821	876	816,811,843...847	824	784	786	838	872	873	823	825	855	827	856	864	894	841	853	817	840	842

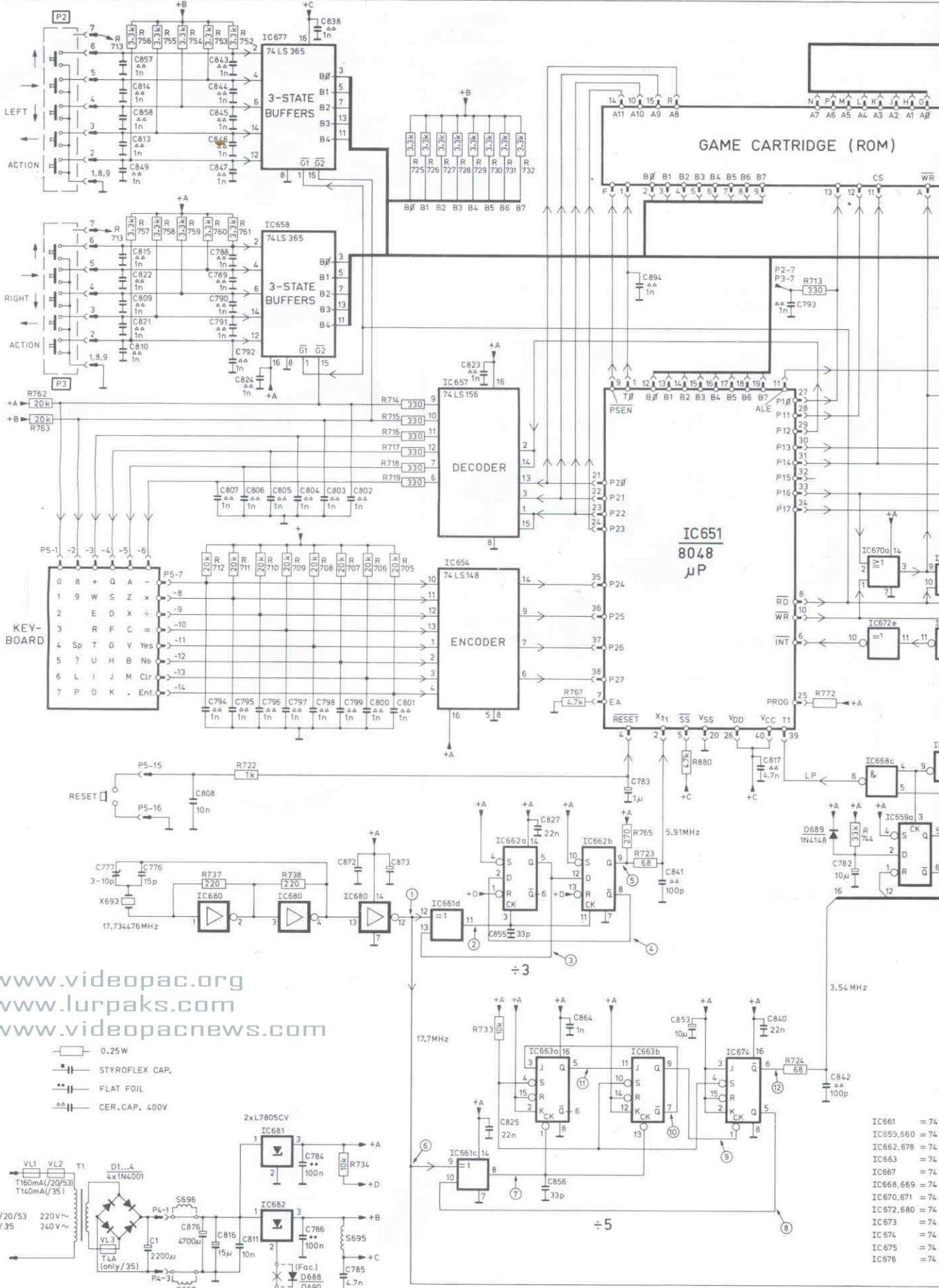

[www.videopac.org](http://www.videopac.org)  
[www.lurpaks.com](http://www.lurpaks.com)  
[www.videopacnews.com](http://www.videopacnews.com)

- 0.25W
- STYROFLEX CAP.
- FLAT FOIL
- CER. CAP. 400V

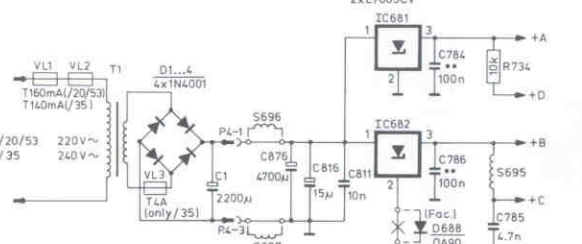

D-S-T	T1	D1...4	S696, S697	D688	S695	D689								
R	705-740	737	722, 711, 738, 710	709	708	707, 734, 706	705, 714...719	725...732	733	723	724	713		
R	761-	762, 763	756, 757, 755, 758, 754, 759, 753, 760, 752, 761							767	765	880	772	744

56d 568b 73d	670b 559b 555 672b 780	673h 554	667 673a	665 652 656 670c	671a 671	672a 671c 672d 657a	673c	653 671b 669c 673b 659a 660a 659d	676 651a 675a 660b 675b 678b 678a 679 651b	IC
618	826 812 851	850	829 830	869 868	832 835	819 854 871 833	865 837.875.836	874	839.820.864.859.860.863.862.861 811-	766 776-810

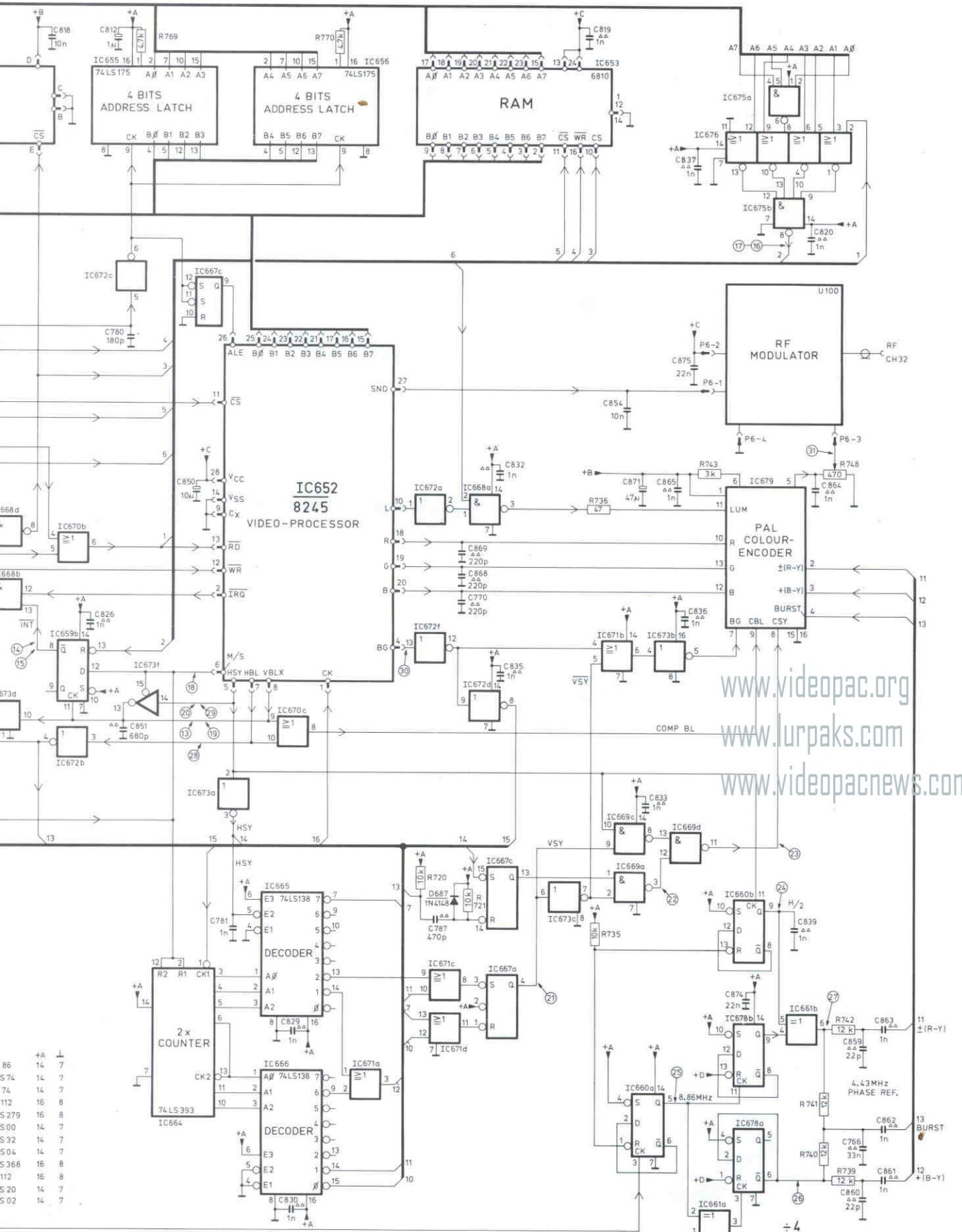

www.videopac.org  
www.lurpaks.com  
www.videopacnews.com

86 S 74 74 S 279 S 00 S 32 S 04 S 368 112 S 20 S 02	14 14 14 14 14 14 14 14 14 14 14 14	7 7 7 7 7 7 7 7 7 7 7 7	D687	769	770	720	721	736 735	743	740 739 741 748	D-S-T R
											22 466 E8





8.677	IC652.656.654.675.679	IC672.670.657.660.661.D689.D687.IC667.671.665.664.659.680.662.678.X693.IC669.666.673.668.663.674
	794÷807	823 825.779.780.826.831.782.778.827 781.787 830.828 776.777.760
58÷870.864.850.854.875.865.871		841.842.835.855.863.839.859.856.867.862.874.836.866.832÷834.861.840.851.853
80	766.705÷712.743 748	714÷719.744.742.735.721.741 720 734÷740

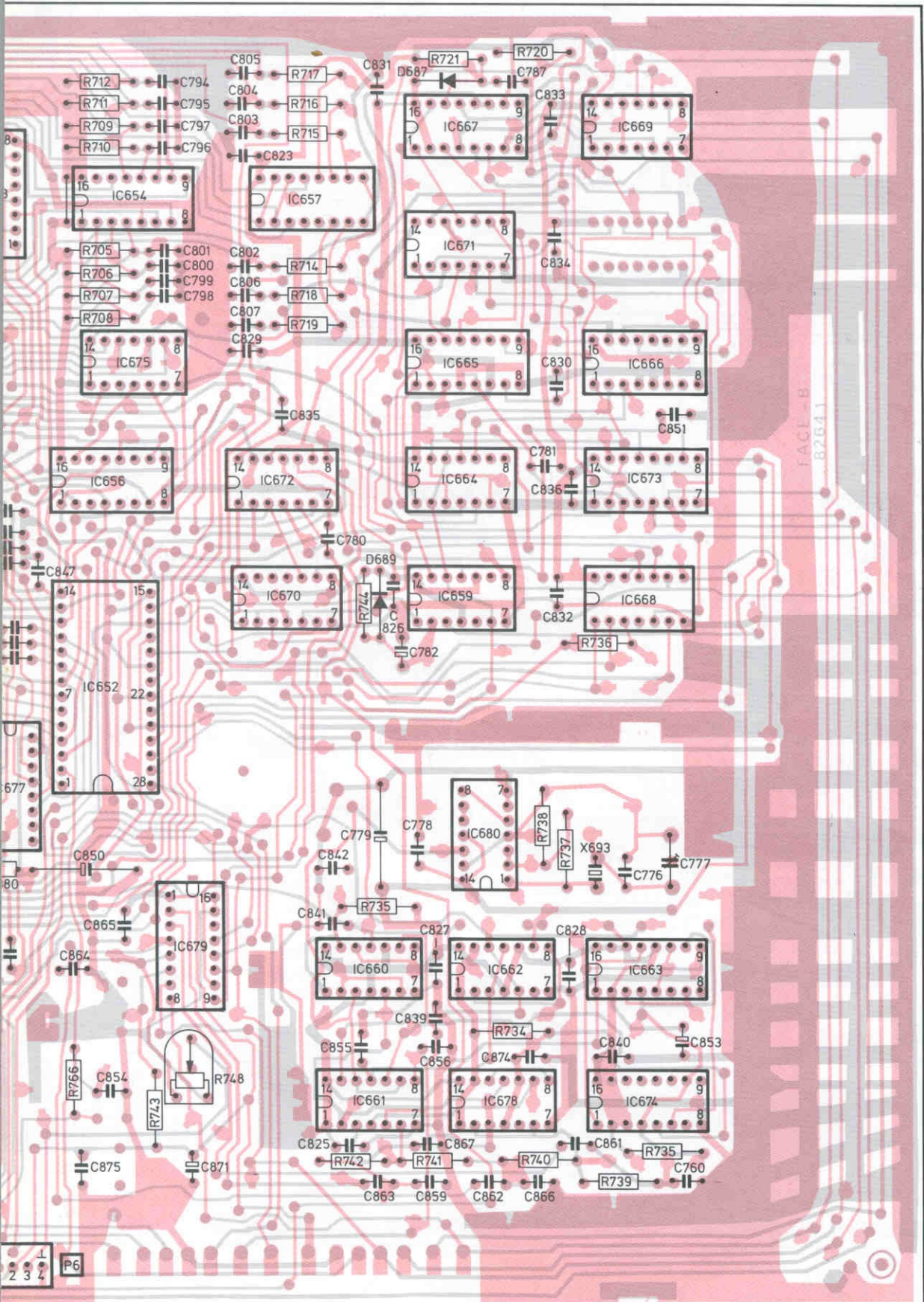

www.videopac.org  
 www.lurpaks.com  
 www.videopacnews.com

### REPAIR METHOD

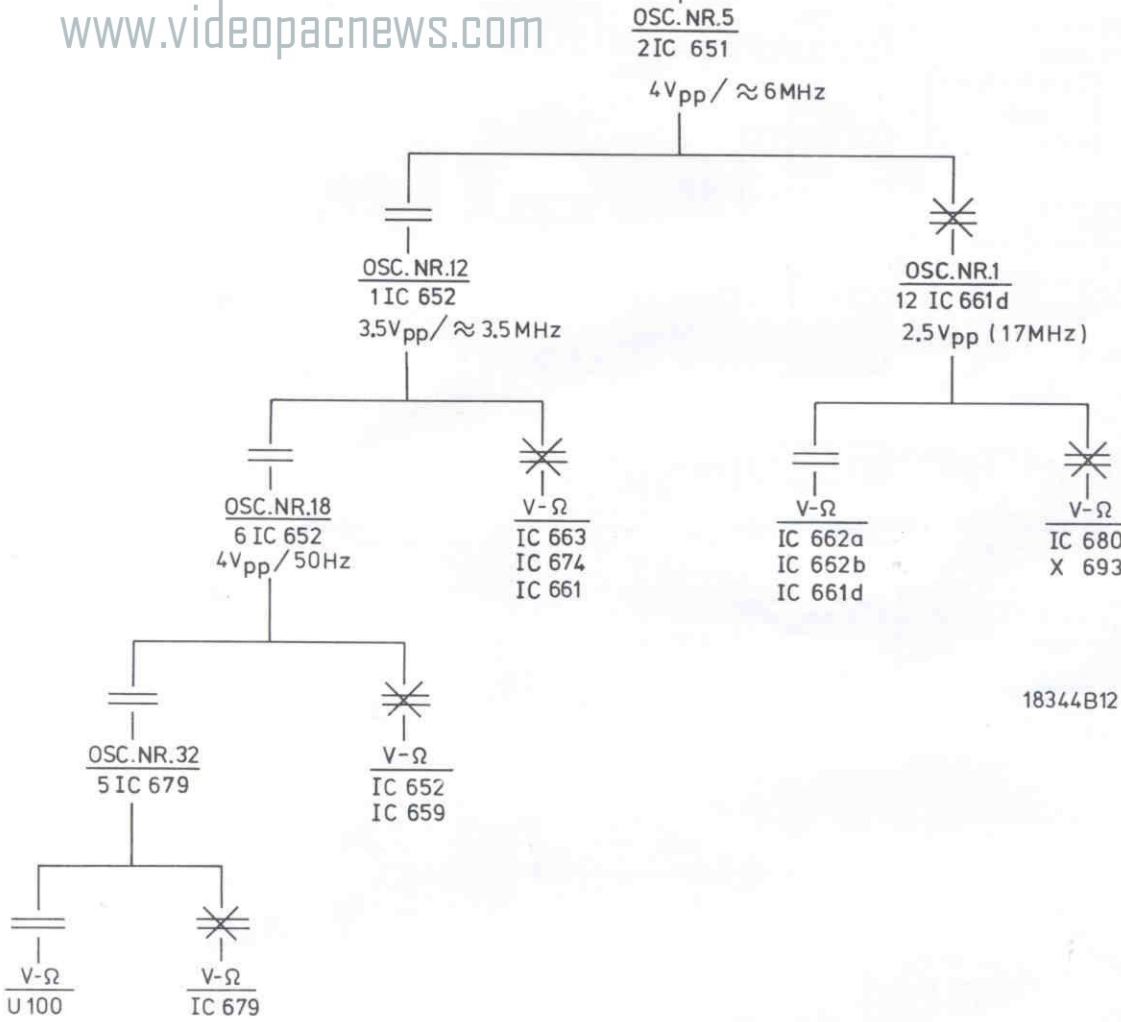
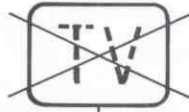

www.videopac.org  
 www.lurpaks.com  
 www.videopacnews.com

MISC	C	R
IC681		
IC682	815	
	876	
	849	
	814	
	813	
	784	
	827	
	786	752
	857	761
	858	
	810	
	808	
	821	
	809	722
	816	
	818	
	811	
	793	
		762
		763
		713
		852
		785
		783
		817
		769
S695	837	771
	812	725
	824	732
IC653		
IC651	819	
IC655	788	
IC676	792	
	843	767
	846	
IC658		
IC677	868	880
	870	
	847	
	838	766
	850	705
IC652	864	712
IC656	875	
IC654	854	
IC675	865	
		74.3
	794	
IC679	807	
	871	
	823	
	829	74.8
	835	
IC672	841	
IC670	842	714
IC657	780	719
	779	
	855	
IC660	825	74.2
IC661	831	74.4
D689	826	
D687	782	735
	778	
IC667	863	741
IC671	827	
IC665	839	721
IC664	856	
IC659	856	
IC680	867	
IC662	859	
IC678	862	734
		720
	787	740
	832	
	832	738
	834	737
X693	781	736
	830	739
IC669	836	
	866	
IC666	874	
IC673	828	735
IC668	861	
IC663	840	
IC674	776	
	851	
	777	
	853	
	760	



